



SAFETY WARNING - PLEASE READ CAREFULLY

WARNING - Be certain electrical power is OFF before and during installation and maintenance.

WARNING - Risk of fire and/or electric shock.

WARNING - Risk of fire or electric shock. For install by qualified electrician only. Do not attempt installation if not qualified.

WARNING - Verify that supply voltage is correct by comparing it with the luminaire label information.

WARNING - To prevent wiring damage or abrasion, do not expose wiring to edges of sheet metal or other sharp objects. All wiring connections should be capped with UL approved wire connectors.

WARNING - Wear gloves and safety glasses at all times when removing luminaire from carton, installing, servicing or performing maintenance.

Included Parts

- A. (1) Vapor Tight fixture
- B. (2) Mounting brackets
- C. (2) V-hanging clips
- D. (4) Mounting screws
- E. (4) Rubber washers
- F. (4) Steel washers
- G. (4) Anchors

Maintenance

Perform visual, electrical, and mechanical inspections on a regular basis. The environment and frequency of use should determine this. However, it is recommended that checks be made at least once per year.

After turning off the main power, check the electrical system to ensure all connections are clean and tight.

Mechanically check that all parts are properly assembled.

Exploded View

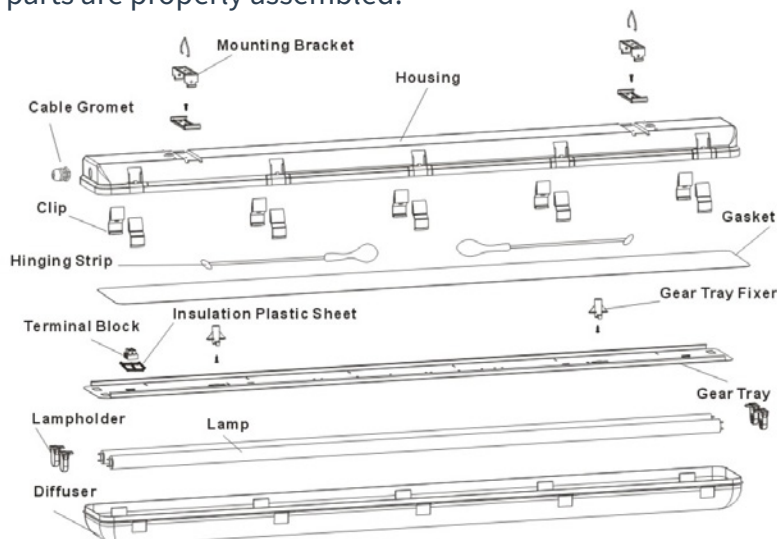

Installation:

1. Turn off all power before attempting installation.
2. Pry open the clips to remove the diffuser. See Figure 1.
3. Turn the Gear Tray Fixers to pull out the Gear Tray. Remove and inspect the contents of the hardware bag.
4. Begin wiring set up. See Figure 2. Route lines through Cable Gromet.
5. Replace and secure Gear Tray with Gear Tray Fixers. Install or replace lamps. See Figure 3. Lamp the fixture with Straits X-Series T8 LED lamps. **The LED Strip Fixture is pre-wired for single-ended connections only.**
6. Replace diffuser and secure with clips.

Surface Mount Installation: Mount included brackets 35 inches apart. Lock Vapor Tight fixture into brackets. See Figure 4a & 4b.

Suspended Installation: Insert included V-hanging clip into Mounting Bracket. Attach Mounting Bracket to fixture. Suspend from ceiling with chain (not included). See Figure 5a & 5b.

Figure 1.

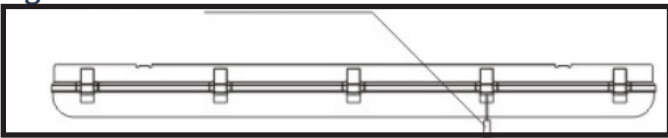

Figure 2.

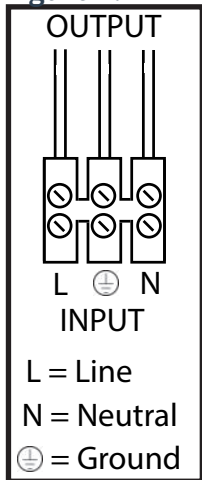

Figure 3.

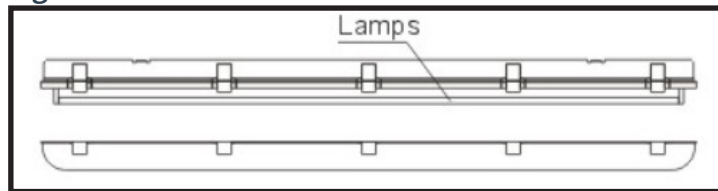

Figure 4a.

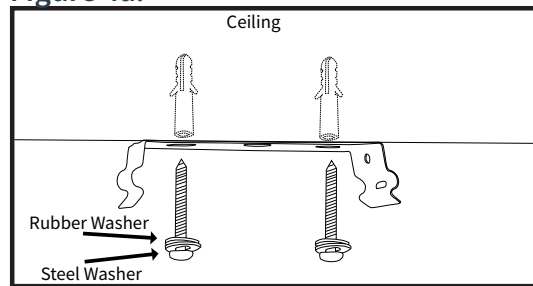

Figure 4b.

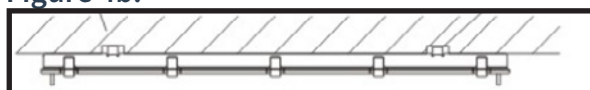

Figure 5a.

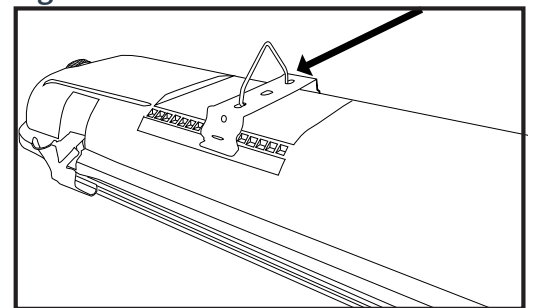

Figure 5b.

