

DUSK TO DAWN LED

Installation Guide

WARNING

1. Turn power off before inspection, installation or removal.
2. The installation should be performed by qualified electricians or lighting technicians.
3. Before conducting any installation, maintenance, or removal, disable all power to the luminaries and wait until the fixture cool down.
4. Do not touch the fixture while it is in service.
5. If there is any problem with the fixture, DO turn off power and DO NOT attempt repair unless you are a qualified technician or the customer service member.
6. This luminaire is designed to operate in ambient temperatures ranging from -40°C to 40°C and to be horizontally mounted with the LEDs facing down.
7. This product is not available for several special environments, such as places with corrosive gas liquids or high pressure water vapor.

Wall Mounting

1. Place mounting section of fixture onto desired mounting surface, mark and drill holes for mounting.
2. Mount the fixture with bolts provided. Install the two bottom screws first. Place the fixture on the two bottom screws and install the top screw. Tighten the top screw first and then tighten the remaining screws.
3. Make wiring connections in the fixture. (White to Neutral lead, Black to Line lead, Yellow Green to Ground lead)
4. Put the cord protection bracket back on the fixture and fix it with screws provided.
5. Installation is completed.

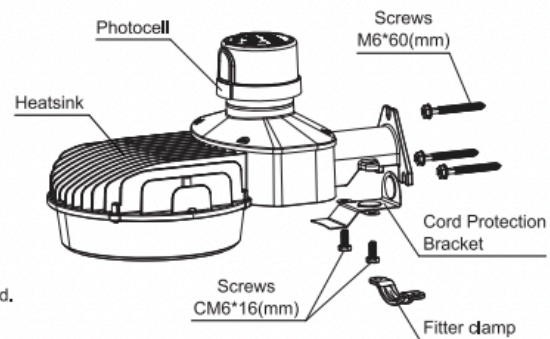





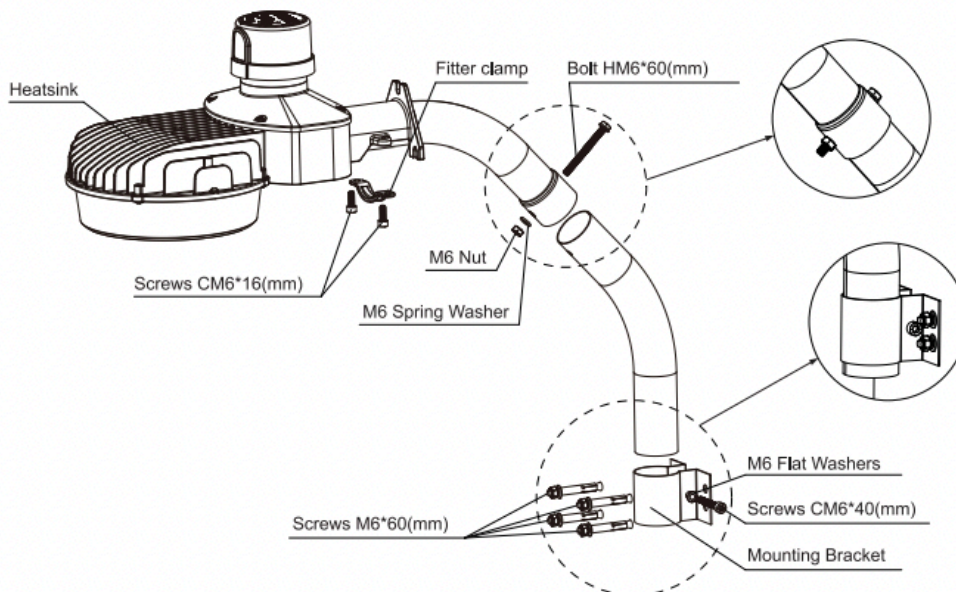









Arm Mounting(Optional)

1. Remove the two poles and secure the two poles connections by the bolt provided as shown in the view.
2. Using the mounting bracket provided to secure the pole to the wall and tighten the fixing screws.
3. Lead the power supply cable and connect it to the fixture input cable. (White to Neutral lead, Black to Line lead, Yellow Green to Ground lead)
4. Insert the fixture into the pole, fix the fixture to the light pole through the fitter clamp, and tighten the fixing screws.
5. Check that the fixture is firmly installed.
6. Installation Completed.



ACCESSORY LIST

Mounting Type	Accessory	Specifications	Quantity
Wall Mount (Standard)	 Cord protection board	L Shape Cord protection board	1
	 Screws	CM6*16-SS, Stainless Steel Hexagon flat head bolt	2
	 Screws	M6*60, Hexagon flanged bottom cross self tapping screw	3
	 Fitter clamp	Slipfitter	1
Arm Mount (Sold separately)	 Bracket	Ω Shape bracket	1
	 Fitter clamp	Slipfitter	1
	 Screws	CM6*16-SS, Stainless Steel Inner Hexagon head bolt	2
	 Screws	M6*60, Stainless Steel Expansion Screw	4
	 Screws	CM6*40-SS, Stainless Steel Inner Hexagon head bolt	1
	 Pole Accessories	Arm Mounting bracket (UP)	1
	 Pole Accessories	Arm Mounting bracket (DOWN)	1
	 Bolt	HM6*60mm	1
	 Nut	M6	2
	 Flat Washers	M6	1
	 Spring Washer	M6	1